



A superior selection that integrates practical functionality with a beautiful design aesthetic for today's modern home.

OUR TRUSTED BRANDS

Lincoln Sentry is delighted to present a contemporary suite of kitchen, outdoor and laundry sink solutions from industry-leading manufacturer Oliveri. We supply the full range of quality Oliveri products, including those that may not be in this catalogue. Discover more about this exceptional Australian company at lincolnsentry.com.au





Oliveri's commitment to the environment

As well as being a name synonymous with style and quality, Oliveri maintains their long-standing focus on responsible interactions with the planet. Their locally made and imported products are manufactured to stringent health and safety standards and comply with all environmental certification policies. The company is also a proud signatory of the Australian Packaging Covenant (APC).



Sustainable materials

Oliveri works with sustainable and recyclable materials, and their Adelaide-based factory operates within a 'zero waste-to-landfill' process.



Made to last

Oliveri products are designed to stand the test of time. All kitchen sinks come with a lifetime manufacturer's warranty and their tapware offers warranties of up to 15 years.



Recyclable packaging

All materials used in Oliveri bathroom packaging are 100% recyclable, and the company is well on its way to ensuring that all kitchen packaging meets these same standards.



Products designed to stand the test of time



Choosing the perfect sink



Follow these simple steps to tailor a system that complements your kitchen design.

Please note the full Oliveri range may not be featured in this brochure, however it may be found at www.lincolnsentry.com.au/oliveri

STEP BY STEP

01

Installation

Topmount sinks are installed above the bench top, undermount below, and flushmount are installed flush with the bench top. We recommend you go for a topmount sink when using a laminate benchtop.



02

Cabinet size

Check that your cabinet is wide enough (left to right) and deep enough (front to back) to accommodate your chosen sink.



03

Configuration

How many bowls do you want? How many drainers, if any at all? And do you want the bowl on the left or right hand side?



04

Finish

Sinks come in polished, brushed and coloured stainless steel as well as granite finishes.



05

Bowl size

Do you want deep bowls for submerging baking trays and other cooking utensils? Or do you just need enough space to wash dishes too fragile for the dishwasher?



06

Pressed or fabricated

Pressed bowls are made from drawing the shape of the bowl out of a sheet of stainless steel, while fabricated bowls are made by folding their shape and welding its sides. Generally fabricated sinks will allow for tight radius edges, while pressed bowls will have a rounder, more traditional shape.



07

Tap integration

Do you need a big tap landing for multiple taps? Or do you prefer a sleeker look with no tap landing?



08

Accessories

Check what custom-made accessories are available for your sink, to make the most of your sink space.



09

Warranty & service

All Oliveri sinks have a lifetime manufacturer's warranty*. For more information visit oliveri.com.au



Goose neck vs. single lever tap

Goose neck taps make a grand statement in your kitchen, while a single lever tap is simple in design, offering a low-profile look.



Finish

Today, kitchen taps come in an array of finishes from polished chrome to matte black and white. Choose a finish that compliments the rest of your kitchen appliances.



Spray and select button

Some mixers have an easy-flick button that changes the water pressure from high pressure to shower spray. You can also choose a select button that allows you to stop and start the water flow.



Water pressure

Be sure to check that your water pressure is compatible with the guides specified within your warranty.



Pull out mixer

A pull out mixer adds new functionality to your kitchen tap. The pull out gives you extra reach and is particularly helpful when filling pots and vases.

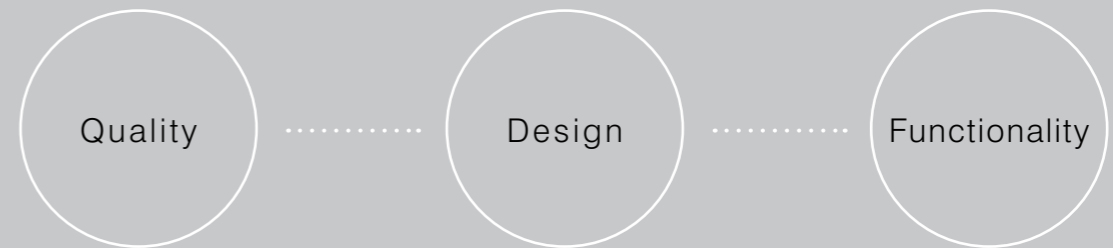

Trusted name

Look for a reputable brand that supplies quality products complying with Australian Standards.



Warranty

Compare warranties across products and look for the brand with the most confidence in their products. Oliveri taps come with a 10-15 year warranty*.



Watermark

Ensure that the tap you are purchasing has the Watermark Logo (you can usually find it at the back of the tap). This confirms that the tap complies with Australian Standards.



WELS rating

This rating is designed by the Australian government to indicate the water efficiency of taps and other water related products. The higher the star rating (out of 6) the more water efficient it is.

Selecting the right tap

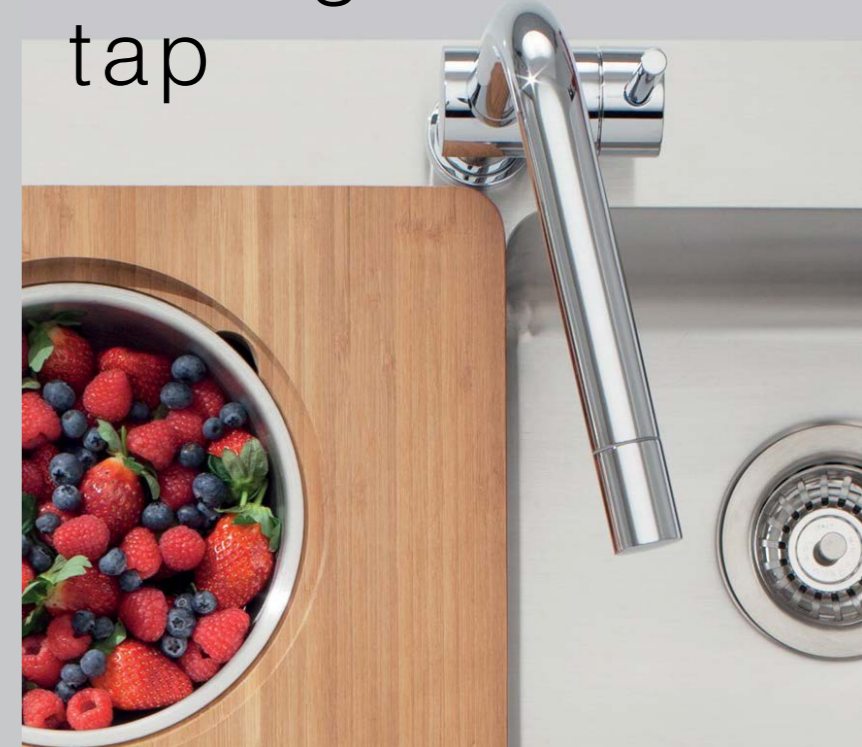

SANTORINI RANGE

FEATURES



Italian made

Santorini sinks are made in Italy to ensure premium quality and reliability.



Yours for life

This rock solid sink comes with a lifetime manufacturer's warranty* for your peace of mind.



Glass top

This show stopper comes with two glass panels that when closed completely conceal the sink bowls, creating an uninterrupted benchtop surface with a sleek look to match modern appliances.

ST-BL1566GT
1-487-625

860W X 510H X 235D
Main Bowl 3 (X2) / 33 Litre



● ST-BL1520
1-487-616

○ ST-WH1520
1-487-627
(Reversible)

860W X 500H X 200D
Main Bowl 2 / 34 Litre



● ST-BL1564
1-487-622

○ ST-WH1564
1-487-630

860W x 510H x 210D
Standard Bowl 1 (x2) / 32 litre



● ST-BL1563U
1-487-621

○ ST-WH1563U
1-487-629

860W X 435H X 210D
Standard Bowl 1 (X2) / 32 Litre



● ST-BL1550U
1-487-619

○ ST-WH1550U
1-487-628

560W X 435H X 200D
Large Bowl / 39 Litre



Available colours

- Black
- White

- TOPMOUNT SINK
- UNDERMOUNT SINK
- FLUSHMOUNT SINK
- LAUNDRY
- ALFRESCO

Scratch resistant

This resilient sink is ready to battle your knives and forks. If it does scratch, you can buff them out with a bit of elbow grease and multi purpose cleaner.

Heat resistant

The granite is able to withstand thermal shocks and is heat resistant up to 280°C. But we do recommend using a surface protector for hot pots which can reach up to 600°C.

Stain resistant

Dirt and stains can easily be removed by gently wiping the sink with hot water and detergent, and then rinsing.

Easy to clean

An active agent in the sink resists limescale making it easier to clean.

Heat and sound insulation

Helps maintain the water temperature and absorbs noise.

Antibacterial

Removes bad smells and pollutant substances often found in the kitchen.

DESIGN TIP

For a modern feel choose black handles to match the black sink.



Moritz / Black Handle

For further information visit

www.lincolnsentry.com.au/handles

* Refer to www.oliveri.com.au/service-and-warranty-au for warranty details.



Featured products:
Santorini sink (1-487-616)
and Vilo pull out spray mixer
(1-488-014)

SANTORINI

This showstopper is constructed from 80% granite and quartz and 20% resin, making it a rock solid performer for your modern kitchen.

SPECTRA RANGE

Premium finish

A premium PVD coating gives the copper and gunmetal sinks their distinctive colour.

Yours for life

This statement sink comes with a lifetime manufacturer's warranty* for your peace of mind.



- SB50SS 1-487-646
 - SB50CU 1-487-648
 - SB50GM 1-487-647
- 540W X 445H X 200D
Large Bowl / 40 Litre
- ○ ○ ○

Universal installation

The Spectra sink is suitable for top, under and flush mounting.

Contemporary design

The 5mm radius corners complete the contemporary design while still being easy to clean.



- SB35SS 1-487-640
 - SB35CU 1-487-642
 - SB35GM 1-487-641
- 790W X 445H X 200D
Large Bowl 40 Litre /
½ Bowl / 18 Litre
- ○ ○



- SB63SS 1-487-643
 - SB63CU 1-487-645
 - SB63GM 1-487-644
- 780W X 445H X 200D
Main Bowl (X2) / 29 Litre
- ○ ○

Included accessories

Along with a chopping board and drainer, every Spectra sink comes with a matching bowl protector to protect the bowl from scratching.



Bamboo preparation board

ACP104F
1-486-021

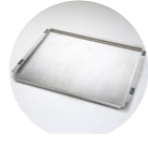

Bench top drainer tray

ACP109
1-486-029

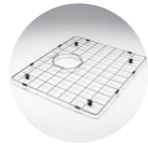

Bowl protector

Code dependent on colour and model of sink.

Please refer to product details on the Lincoln Sentry website to confirm what accessories are included with each model.

- TOPMOUNT SINK
- UNDERMOUNT SINK
- FLUSHMOUNT SINK
- LAUNDRY

FEATURES

The Spectra range comes in three colour options:

- Stainless
- Copper
- Gunmetal

Featured products:
Spectra double bowl (1-487-643)
and Pepe swivel mixer (1-488-023)

SPECTRA

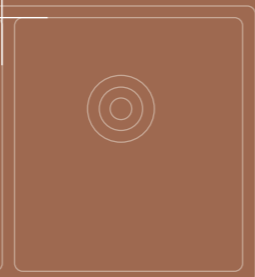

Inspired Design

Oliveri Spectra double bowl sinks come with an inspired design feature in the form of a curved bridge dividing the two bowls. This curved bridge acts as an overflow to safeguard against accidental over filling eliminating the need for an overflow.

* Refer to www.oliveri.com.au/service-and-warranty-au for warranty details.

DESIGN TIP
HAVE YOU THOUGHT ABOUT A SPLASHBACK?

Constructed from durable coated aluminium, our DecoSplash sublimated splashbacks are made to your precise specifications, with your choice of designs or customised images.

For further information visit

www.lincolnsentry.com.au/decosplash



PROFESSIONAL SERIES

FEATURES

Large capacity bowls

Ready to soak your large baking dishes, the Professional sinks have large bowl capacities up to a huge 78 litres.

Yours for life

All sinks bearing the signature Oliveri logo come with a lifetime manufacturer's warranty*.

Premium finish

Constructed from 1.5mm brushed stainless steel, the Professional sink seamlessly fits in with your contemporary appliances.

Wide range

From single to double bowl, with or without drainer, you'll find a configuration to fit your kitchen design. The Professional is even available in a unique Butler style.

Contemporary design

The 10mm tight radius corners are easy to clean while still providing the contemporary look.

DESIGN TIP

MULTI USE PREPARATION KIT

A complete food preparation kit with board and colander. Just drop into place for extra space and instant convenience.



PR1111 1-487-657 LH Bowl 1450W X 505H X 225D Grande Bowl 46 Litre
 PR1112 1-487-658 RH Bowl ¾ Bowl / 35 Litre



PR1121 1-487-659 LH Bowl 1040W x 505H x 225D Grande Bowl / 46 Litre
 PR1122 1-487-660 RH Bowl



PR1181 1-487-662 550W x 505H x 225D Grande Bowl / 46 Litre



PR1163U 1-487-665 835W x 505H x 225D Standard Bowl (X2) / 39 Litre



PR1180U 1-487-666 550W x 455H x 225D Grande Bowl / 46 Litre

Accessories

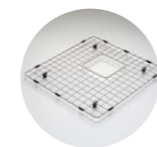

Bowl protector
 Protects the bowl from scratching. A protector is provided for each bowl.

- ACPSQ8 1-486-051 Grande
- ACPSQ5 1-486-049 Standard
- ACPSQ3 1-486-048 3/4 Bowl

- ⊖ TOPMOUNT SINK
- ⊕ UNDERMOUNT SINK
- ⊖ FLUSHMOUNT SINK
- ⊕ LAUNDRY

Please refer to product details on the Lincoln Sentry website to confirm what accessories are included with each model.

* Refer to www.oliveri.com.au/service-and-warranty-au for warranty details.

PROFESSIONAL BUTLER SERIES



Featured products: Professional Butler Series sink (1-487-655) and Vilo flexible hose mixer (1-488-005)



PR1290U 1-487-655 810W x 540H x 225D Mega Bowl / 78 Litre



PR1263U 1-487-656 835W x 540H x 225D Standard Bowl (X2) / 39 Litre

Included accessories

Along with a chopping board and drainer, every Spectra sink comes with a matching bowl protector to protect the bowl from scratching.

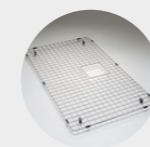

Bowl protector
 Protects the bowl from scratching. A protector is provided for each bowl.

- ACPSQ9 1-486-052 Mega Bowl
- ACPSQ5 1-486-049 Standard Bowl

Please refer to product details on the Lincoln Sentry website to confirm what accessories are included with each model.

Optional accessories



Drainer baskets
 Drain, rinse or stack. Can be used inside the bowl or on the drainer. ACP31 1-486-055

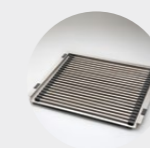

Bench top drainer set
 Protects your benchtop when draining dishes or defrosting food. ACP110 1-486-030

BUTLER SERIES PROFESSIONAL

SONETTO RANGE

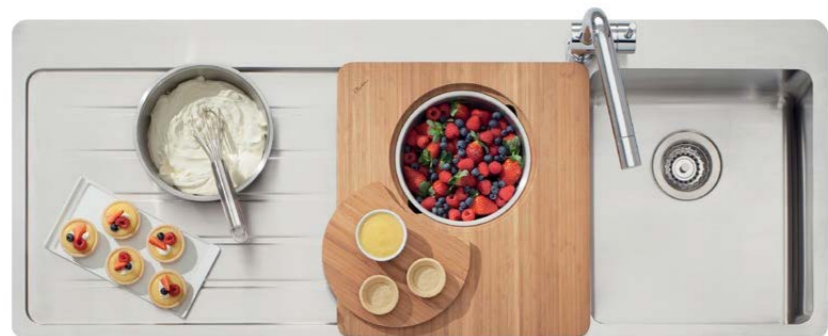

SN1071
1-487-971
LH Bowl

SN1072
1-487-972
RH Bowl

1300W x 510H x 205D
¾ Bowl (X2) / 30 Litre

○ ○

○ TOPMOUNT SINK
○ UNDERMOUNT SINK
○ FLUSHMOUNT SINK
☑ LAUNDRY
☑ ALFRESCO



SN1011
1-487-911
LH Bowl

SN1012
1-487-912
RH Bowl

1415W x 510H x 205D
Large Bowl / 39 Litre
¾ Bowl / 30 Litre

○ ○



SN1063U
1-487-963

785W x 455H x 205D
¾ Bowl (X2) / 30 Litre

○



SN1051
1-487-951

520W x 510H x 205D
Large Bowl / 39 Litre

○ ☑



SN63TU
1-487-962

785W x 455H x 205D
¾ Bowl (X2) / 30 Litre

○ ○



SN30TU
1-487-932

405W x 455H x 205D
¾ Bowl / 30 Litre

○ ○ ☑ ☑

Universal installation /

These universal sinks offer greater flexibility as they are suitable for both topmount and undermount installation.

Topmount sinks offer a classic, more traditional look and will work with any bench top material.

An undermount sink will create a sleek and modern style and are best suited to natural or engineered stone bench tops.

FEATURES

Premium finish

Constructed from 1.2mm brushed stainless steel, the Sonetto sink seamlessly fits in with your contemporary appliances.

Yours for life

All sinks bearing the signature Oliveri logo come with a lifetime manufacturer's warranty*.

Unique drainer design

The unique drainer design drains water efficiently into the sink.

Contemporary design

The 25mm tight radius corners are easy to clean while still providing the contemporary look.

Accessories

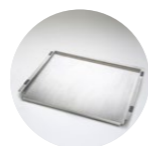

Benchtop Drainer Tray*
ACP109
1-486-029



Bamboo Board*
ACP104F
1-486-021

*Not all models

Please refer to product details on the Lincoln Sentry website to confirm what accessories are included with each model.

* Refer to www.oliveri.com.au/service-and-warranty-au for warranty details.



Featured products:
Sonetto sink
(1-487-962) and Pepe
swivel mixer (1-488-021)

SONETTO



Featured:
Sonetto 1&3/4 RH Bowl
(1-487-912)

+

DESIGN TIP

Topmount sinks offer a classic, more traditional look and will work with any bench top material

APOLLO RANGE

FEATURES

Premium finish

Constructed from 1.2mm brushed stainless steel, the Apollo sink seamlessly fits in with your contemporary appliances.

Yours for life

All sinks bearing the signature Oliveri logo come with a lifetime manufacturer's warranty*.

Large tap landing

A large tap landing allows for more than just one tap hole - perfect for your satellite filter tap or instant boiling tap.

Accessories



Bamboo preparation board

A bamboo board perfect for food preparation that fits into the bowl.

ACP124
1-486-032

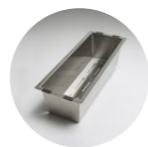

Colanders

Fits into the bowl and is the perfect place to strain pasta or rinse vegetables.

ACP134
1-486-036

Please refer to product details on the Lincoln Sentry website to confirm what accessories are included with each model.



AP1411
1-487-680
LH Bowl
1200W x 500H x 200D
Main Bowl / 29 Litre
¾ Bowl / 21 Litre

AP1412
1-487-681
RH Bowl



AP1464
1-487-689
Main Bowl (X2) / 29 Litre



AP1451
1-487-688
Main Bowl / 29 Litre



AP1491
1-487-690
Mega Bowl / 60 Litre

- TOPMOUNT SINK
- ◌ UNDERMOUNT SINK
- ◌ FLUSHMOUNT SINK
- 🗑️ LAUNDRY



DESIGN TIP

Undersink storage

Clear work areas and maximise space with our range of under sink storage accessories. From customised shelving and drawers to concealed waste management and wire storage racks, we'll help you stay organised.

To view our full range visit

www.lincolnsentry.com.au

* Refer to www.oliveri.com.au/service-and-warranty-au for warranty details.



Featured products:
Apollo sink (1-487-680) and
Vito pull out mixer (1-488-007)

NU-PETITE RANGE

Featured:
Nu-Petite 1&1/2 RH Bowl
(1-487-514)

NU-PETITE



FEATURES

Proudly Aussie made, the Nu-Petite is one of the many ranges of stainless steel sinks that is produced in Australia.

Yours for life

This unique sink comes with a lifetime manufacturer's warranty* for your peace of mind.

Premium material

Constructed from 304 grade, 18/10 stainless steel for excellent hygiene and durability.

Custom made accessories

Custom fitted bamboo chopping board, colander and utility tray quickly transforms the sink into a food preparation centre.

Large bowl capacity

With the main bowl holding up to 30 litres, you'll be able to soak your large pots and pans.

Accessories



Bamboo preparation board

A bamboo board perfect for food preparation that fits into the bowl.

AC65
1-486-066



Colanders

Fits into the bowl and is the perfect place to strain pasta or rinse vegetables.

AC62
1-486-064

Please refer to product details on the Lincoln Sentry website to confirm what accessories are included with each model.



NP671
1-487-530
LH Bowl
NP672
1-487-532
RH Bowl

1250W x 500H x 200D
Main Bowl / 30 Litre
5 Side Bowl / 28 Litre

⊖



NP621
1-487-526
LH Bowl
NP622
1-487-529
RH Bowl

825W x 500H x 200D
Main Bowl / 30 Litre

⊖ ⊕



NP611
1-487-516
LH Bowl
NP612
1-487-519
RH Bowl

1150W x 500H x 200D
Main Bowl / 30 Litre
¾ Bowl / 11 Litre

⊖



NP601
1-487-511
LH Bowl
NP602
1-487-514
RH Bowl

1080W x 500H x 200D
Main Bowl / 30 Litre
½ Bowl / 9 Litre

⊖ ⊕



NP663
1-487-539

875W x 500H x 200D
Main Bowl / 30 Litre
5 Side Bowl / 28 Litre

⊖ ⊖ ⊕



NP60U
1-487-543

890W x 515H x 200D
Main Bowl (X2) / 30 Litre

⊖ ⊕



NP63U
1-487-540

881W x 506H x 200D
Main Bowl / 30 Litre
5 Side Bowl / 28 Litre

⊖ ⊕



NP61U
1-487-502
LH Bowl
NP62U
1-487-503
RH Bowl

791W x 506H x 200D
Main Bowl / 30 Litre
¾ Bowl / 11 Litre

⊖ ⊕

NP61U shown

- ⊖ TOPMOUNT SINK
- ⊖ UNDERMOUNT SINK
- ⊖ FLUSHMOUNT SINK
- ⊕ LAUNDRY
- ⊕ ALFRESCO

MONET RANGE

FEATURES

Proudly Aussie made

The Monet is one of the many ranges of stainless steel sinks that is produced in Australia.

Yours for life

This unique sink comes with a lifetime manufacturer's warranty* for your peace of mind.

Premium material

Constructed from 304 grade, 18/10 stainless steel for excellent hygiene and durability.

Unique shape

The unique shape of the Monet bowls have made it a crowd favourite.

Large bowl capacity

With the main bowl holding up to 24 litres, you'll be able to soak your large pots and pans.



MO711
1-487-409
LH Bowl
MO712
1-487-411
RH Bowl

1100W x 500H x 180D
Main Bowl / 24 Litre
¾ Bowl / 11 Litre



MO771
1-487-417
LH Bowl
MO772
1-487-419
RH Bowl

1200W x 500H x 180D
Main Bowl (X2) / 24 Litre



MO763
1-487-415

815W x 500H x 180D
Main Bowl (X2) / 24 Litre



MO70U
1-487-420

820W x 500H x 180D
Main Bowl (X2) / 24 Litre

Included accessories



Bamboo preparation board
A bamboo board perfect for food preparation that fits into the bowl.

AC74
1-486-069



Colanders
Fits into the bowl and is the perfect place to strain pasta or rinse vegetables.

AC72
1-486-067

Please refer to product details on the Lincoln Sentry website to confirm what accessories are included with each model.

- TOPMOUNT SINK
- UNDERMOUNT SINK
- FLUSHMOUNT SINK
- ☒ LAUNDRY
- ☒ ALFRESCO

PETITE RANGE

FEATURES

Proudly Aussie made

The Petite is one of the many ranges of stainless steel sinks that is produced in Australia.

Yours for life

All sinks bearing the signature Oliveri logo come with a lifetime manufacturer's warranty*.

Premium material

Constructed from 304 grade, 18/10 stainless steel for excellent hygiene and durability.

Custom made accessories

Custom fitted bamboo chopping board and colander quickly transform your sink into a food preparation centre.



PE353
1-487-353

1430W x 480H x 180D
Main Bowl (X2) / 21 Litre



PE311
1-487-311
LH Bowl
PE312
1-487-312
RH Bowl

1080W x 480H x 180D
Main Bowl / 21 Litre
¾ Bowl / 11 Litre



PE301
1-487-301
LH Bowl
PE302
1-487-302
RH Bowl

980W x 480H x 180D
Main Bowl / 21 Litre
½ Bowl / 7 Litre



PE321
1-487-321
LH Bowl
PE322
1-487-322
RH Bowl

770W x 480H x 180D
Main Bowl / 21 Litre

DESIGN TIP

CUTLERY TRAYS

Discover our flexible modular trays that allow you to utilise drawer space in more creative ways. Our range of pre-cut, uncut or made-to-measure options help you create inserts that fit perfectly within drawer dimensions.



Included accessories



Bamboo preparation board
A bamboo board perfect for food preparation that fits into the bowl.

AC15
1-486-042



Colanders
Fits into the bowl and is the perfect place to strain pasta or rinse vegetables.

AC18
1-486-047

Please refer to product details on the Lincoln Sentry website to confirm what accessories are included with each model.

- TOPMOUNT SINK
- UNDERMOUNT SINK
- FLUSHMOUNT SINK
- ☒ LAUNDRY
- ☒ ALFRESCO

DESIGN TIP

Tea towel pullouts

Handy when you need them and gone when you don't. Tea towel pull outs offers a styling solution to a practical everyday need. See our range of side-mounted tea towel rails offering a selection of designs and finishes.

* Refer to www.oliveri.com.au/service-and-warranty-au for warranty details.

DIAZ RANGE



FEATURES

Proudly Aussie made

The Diaz is one of the many ranges of stainless steel sinks that is produced in Australia.

Yours for life

All sinks bearing the signature Oliveri logo come with a lifetime manufacturer's warranty*.

Custom made accessories

Custom fitted bamboo chopping board, utility tray and colander quickly transforms your sink into a food preparation centre.

Large tap landing

A large tap landing allows for more than just one tap hole - perfect for your satellite filter or instant boiling tap.

DIAZ

Featured:
Diaz double undermount bowl (1-487-619)

LAKELAND



FEATURES

Proudly Aussie made

The LakeLand is one of the many ranges of stainless steel sinks that is produced in Australia.

Yours for life

All sinks bearing the signature Oliveri logo come with a lifetime manufacturer's warranty*.

Premium material

Constructed from 304 grade, 18/10 stainless steel for excellent hygiene and durability.

LAKELAND



DZ121
1-487-985
LH Bowl
DZ122
1-487-987
RH Bowl
770W x 480H x 180D
Main Bowl / 21 Litre



DZ111
1-487-979
LH Bowl
DZ112
1-487-982
RH Bowl
1080W x 480H x 180D
Main Bowl / 21 Litre
¼ Bowl / 11 Litre



DZ171
1-487-998
LH Bowl
DZ172
1-488-000
RH Bowl
1200W x 480H x 180D
Main Bowl (X2) / 21 Litre



LL136
1-486-135
LH Bowl
LL137
1-486-140
RH Bowl
1080W x 480H x 155D
Main Bowl / 17 Litre
¼ Bowl 12 Litre



LL156
1-486-165
LH Bowl
LL157
1-486-170
RH Bowl
1200W x 480H x 155D
Main Bowl (X2) / 17 Litre

Optional accessories



Bamboo preparation board

A bamboo board perfect for food preparation that fits into the bowl.

AC01
1-481-019



Colanders

Fits into the bowl and is the perfect place to strain pasta or rinse vegetables.

AC02W AC06W
1-486-020 1-486-022
3/4 Bowl 1/2 Bowl

Please refer to product details on the Lincoln Sentry website to confirm what accessories are included with each model.



DZ163
1-487-996
770W x 480H x 180D
Main Bowl (X2) / 21 Litre



DZ10U
1-487-977
770W x 480H x 180D
Main Bowl (X2) / 21 Litre



DZ150U
1-487-992
360W x 430H x 180D
Main Bowl / 21 Litre

Included accessories

* No accessories for DZ150U



Bamboo preparation board

AC15
1-486-042



Colanders

AC18
1-486-047

Please refer to product details on the Lincoln Sentry website to confirm what accessories are included with each model.



LL126
1-486-105
LH Bowl
LL127
1-486-110
RH Bowl
980W x 480H x 155D
Main Bowl / 17 Litre
½ Bowl / 7 Litre



LL116
1-486-120
LH Bowl
LL117
1-486-125
RH Bowl
770W x 480H x 155D
Main Bowl / 17 Litre

ULTRAFORM / MARTINI / TITAN RANGE

FEATURES

Proudly Aussie made

The following selection of stainless steel sinks are produced in Australia.

Yours for life

All sinks bearing the signature Oliveri logo come with a lifetime manufacturer's warranty*.

Premium material

Constructed from 304 grade, 18/10 stainless steel for excellent hygiene and durability.

ULTRAFORM



UF13D
1-487-130
1385W x 470H x 190D
Deep Bowl (X2) / 21 Litre



UF01
1-487-001
LH Bowl
UF02
1-487-020
RH Bowl

Please refer to product details on the Lincoln Sentry website to confirm what accessories are included with each model.

- TOPMOUNT SINK
- UNDERMOUNT SINK
- FLUSHMOUNT SINK
- ☺ LAUNDRY
- ☺ ALFRESCO

MARTINI



440
1-487-279
410W x 490H x 190D
Deep Bowl / 21 Litre



MR501
1-487-455
LH Bowl
MR502
1-487-456
RH Bowl

TITAN



TN890U
1-487-480
760W x 455H x 255D
Titan Bowl / 65 Litre

ENDEAVOUR RANGE

FEATURES

Proudly Aussie made

The Endeavour is one of the many ranges of stainless steel sinks that is produced in Australia.

Yours for life

All sinks bearing the signature Oliveri logo come with a lifetime manufacturer's warranty*.

Premium material

Constructed from 304 grade, 18/10 stainless steel for excellent hygiene and durability.

Variety

The Endeavour comes in a number of configurations and installation types to suit your design needs.



EE71
1-487-216
LH Bowl
EE72
1-487-217
RH Bowl



EE11
1-487-204
LH Bowl
EE12
1-487-205
RH Bowl



EE63U
1-487-212
750W x 455H x 155D
Main Bowl (X2) / 17 Litre



EE21
1-487-207
LH Bowl
EE22
1-487-208
RH Bowl



EE64
1-487-210
770W x 480H x 155D
Main Bowl (X2) / 17 Litre

- TOPMOUNT SINK
- UNDERMOUNT SINK
- FLUSHMOUNT SINK
- ☺ LAUNDRY
- ☺ ALFRESCO

* Refer to www.oliveri.com.au/service-and-warranty-au for warranty details.



Featured products:
Titan sink (1-487-480) and
Hansgrohe Talis S2 pull out
spray mixer (1-488-053)



Featured products:
Endeavour 1 & 1/2 bowl
(1-487-204) and
Essentials swivel mixer
(1-488-046)

FINISTA® SINKS

See the wide range of Finista accessories, wire-ware storage, waste management, cutlery and trays.

lincolnsentry.com.au/finista-sinks



DOUBLE BOWL WITH DRAINER

Features & benefits

- Made from 18/10 304 grade stainless steel
- 0.8mm thick with a polished finish and a rolled edge
- Bowl Capacity: 2 x 21 litre
- 10 year warranty (body), 2 year warranty (wastes & clips)*

Inclusions

- 2 x basket wastes - Adjustable clips - Sound pads
- Fitted sealing gasket - Wooden backing board

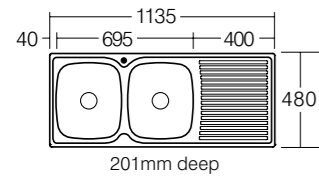

- 1-486-470 Double Left Hand Bowl, 1 Tap Hole
- 1-486-475 Double Right Hand Bowl, 1 Tap Hole

1 & 3/4 BOWL WITH DRAINER

Features & benefits

- Made from 18/10 304 grade stainless steel
- 0.8mm thick with a polished finish and a rolled edge
- Bowl Capacity: 1 x 21 litre, 1 x 12 litre
- 10 year warranty (body), 2 year warranty (wastes & clips)*

Inclusions

- 2 x basket wastes - Adjustable clips - Sound pads
- Fitted sealing gasket - Wooden backing board

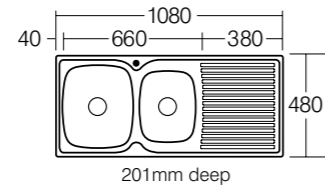

- 1-486-450 1 & 3/4 Left Hand Bowl, 1 Tap Hole
- 1-486-455 1 & 3/4 Right Hand Bowl, 1 Tap Hole

SINGLE BOWL WITH DRAINER

Features & benefits

- Made from 18/10 304 grade stainless steel
- 0.8mm thick with a polished finish and a rolled edge
- Bowl Capacity: 1 x 21 litre
- 10 year warranty (body), 2 year warranty (wastes & clips)*

Inclusions

- 1 x basket wastes - Adjustable clips - Sound pads
- Fitted sealing gasket - Wooden backing board

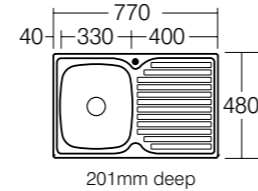

- 1-486-460 Single Left Hand Bowl, 1 Tap Hole
- 1-486-465 Single Right Hand Bowl, 1 Tap Hole

* Refer to www.lincolnsentry.com.au/finista-sinks



WATER FILTERS

FEATURES

Inline, Satellite or 3 way

Choose an inline system to filter through your existing mixer, a satellite system to filter through a designer satellite filter tap or select a filter connection kit to connect to a three-way mixer (sold separately) or existing satellite tap.

Filter change alarm monitor

Included filter change alarm monitor will remind you to change the filter after 12 months.

Easy to change cartridges

Simple bayonet style connection means cartridges are easy to change.

Limescale reduction

Helps to prevent the build-up of limescale.

Latest technology

The latest carbon block technology absorbs chlorine, bad tastes, odours, dirt, rust and cysts** (e.g. giardia and cryptosporidium).

Maintains minerals

Maintains healthy minerals and salts.

Easy installation

Suitable for horizontal or vertical installation with an easy to install, space saving design.

Warranty

6 year warranty and dedicated after sales service for confidence and peace of mind.

* FS5050 Filters mains water to 5 microns.

** Cysts blocked by 1 micron filtration systems only.



SATELLITE WATER FILTRATION SYSTEMS

Filters mains water through a designer satellite filter tap.

- FR7905 Satellite Water Filtration Replacement Cartridge
- 1-488-065



Round goose neck filter tap with water filtration system

- FS7025 Rating: 1 micron
- 1-488-063 Warranty: 6 years*



Square goose neck filter tap with water filtration system

- FS7075 Rating: 1 micron
- 1-488-064 Warranty: 6 years*

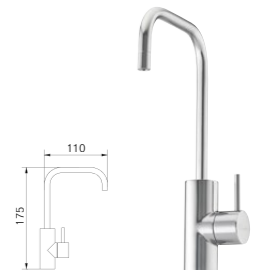

FILTER CONNECTION KIT

Connects to a new or existing 3 way mixer or satellite tap.

- FS7005 3 Way Mixer Tap or Satellite Filter Tap Filter Connection Kit
- 1-488-062
- FR7905 3 Way Mixer Tap or Satellite Filter Tap Replacement Cartridge
- 1-488-065



This filter connection kit can be connected to an Oliveri 3 Way Mixer (sold separately) or an existing 3 way mixer. Alternatively this connection kit can be connected to an existing satellite tap.

INLINE WATER FILTRATION SYSTEMS

Connects to any new or existing mixer tap.

- FS5010 Inline Water Filtration System for Standard Water Use
- 1-488-058
- FR5910 Inline Water Filtration Replacement Cartridge for Standard Water Use
- 1-488-060
- FS5050 Inline Water Filtration System for Harsh Water Use
- 1-488-059
- FR5950 Inline Water Filtration Replacement Cartridge for Harsh Water Use
- 1-488-061



Outdoor Entertaining

Extend the functionality of any home with a practical and modern outdoor kitchen. Enjoy the convenience of entertaining anytime of year, from quick evening dinners to long Sunday lunches, our alfresco kitchen ideas will handle the workload.



Functionality

Choose a sink and tap combination that suits your design. Whether you're creating a fully functional kitchen or a simple bar area, there's a configuration that's sure to work.



Design

While interior design themes within a home can extend to outdoor kitchens, exterior settings present their own opportunities. Create a look that complements the area.



Location

With flexible options you can place your sink and taps in a location that makes cleaning up a breeze. Incorporate a BBQ area and plan an ergonomic layout to suit.

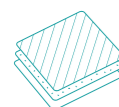

Materials

Outdoor kitchens should be designed to handle tough treatment. Choose hard-working materials, like stainless steel and granite, for lasting durability and resilience.



Shelter

To maintain the quality of an outdoor kitchen, we recommend adequate shelter from harsh weather conditions. Undercover alfresco areas are also easier to keep clean.

Cater to all seasons with practical and stylish glass & aluminium doors



Product Spec:
PROFILE: 50 / 31 Box Glass Champagne [O]
INSERT: Dark Grey (60%) Tempered Glass [O]



DESIGN TIP

Stand up to the elements

Keep your kitchen looking like new with Alsert's weather resistant aluminium and glass cabinet doors. Purpose built for the great outdoors, the innovative range is backed by a 10 year warranty and offers the freedom of customised colours and prints.

VILO RANGE

FEATURES

Italian made

Vilo taps are made in Italy to ensure premium quality and reliability.

Variety

The Vilo tap range comes in a variety of styles, finishes and colours to suit your sink and kitchen design.

Pull out and spray

Choose a pull out mixer with adjustable sprays for added functionality.

Filtered water

Pair these taps with an Oliveri Inline Water Filter for pure filtered water in your own home.

Warranty

15 years

- C CHROME
- B BRUSHED
- S STAINLESS STEEL
- MB MATTE BLACK
- SB SANTORINI BLACK
- SW SANTORINI WHITE

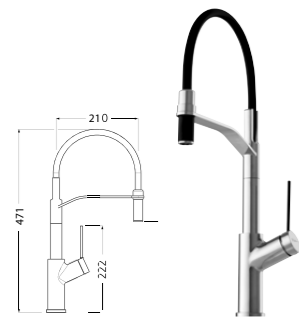

Flexible hose mixer
Maximum pressure / 600kpa

1-488-006 | VT0392C
WELS 4 Star / 6.5L per minute
REG. NO. T20416

1-488-005 | VT0392B
WELS 4 Star / 6.5L per minute
REG. NO. T20415



Pull out spray mixer
Maximum pressure / 600kpa

1-488-016 | VT0426C
WELS 4 Star / 6.5L per minute
REG. NO. T20422

1-488-014 | VT0426B
WELS 4 Star / 6.5L per minute
REG. NO. T20421

1-488-015 | VT0426B-ST-BL
WELS 4 Star / 6.5L per minute
REG. NO. T20421 (V)



Pull out mixer
Maximum pressure / 600kpa

1-488-008 | VT0398C
WELS 4 Star / 6.5L per minute
REG. NO. T20418

1-488-007 | VT0398B
WELS 4 Star / 6.5L per minute
REG. NO. T20417

1-488-009 | VT0398C-BLACK
WELS 4 Star / 6.5L per minute
REG. NO. T20418 (V)

1-488-010 | VT0398C-ST-BL
WELS 4 Star / 6.5L per minute
REG. NO. T20418 (V)

1-488-011 | VT0398C-ST-WH
WELS 4 Star / 6.5L per minute
REG. NO. T20418 (V)

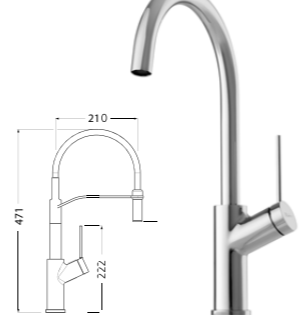

Goose neck mixer
Maximum pressure / 600kpa

1-488-013 | VT0403C
WELS 4 Star / 6.5L per minute
REG. NO. T20420

1-488-012 | VT0403B
WELS 4 Star / 6.5L per minute
REG. NO. T20419

PEPE RANGE

FEATURES

Italian made

Pepe taps are made in Italy to ensure premium quality and reliability.

Variety

The Pepe tap comes in a variety of finishes and colours to suit your sink and kitchen design.

Distinct design

A bold design that will make a statement in your kitchen.

Filtered water

Pair this tap with an Oliveri Inline Water Filter for pure filtered water in your own home.

Warranty

15 years

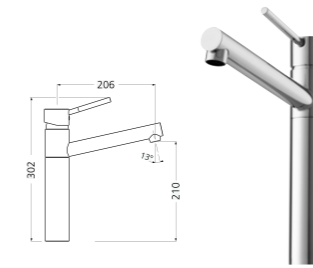

Swivel mixer

Maximum pressure / 600kpa

1-488-023 | PT2010C-BLACK
WELS 4 Star / 7.5L per minute
REG. NO. T20365 (V)

1-488-022 | PT2010C-ST-BL
WELS 4 Star / 7.5L per minute
REG. NO. T20365 (V)

1-488-020 | PT2010C
WELS 4 Star / 7.5L per minute
REG. NO. T20365

1-488-021 | PT2010B
WELS 4 Star / 7.5L per minute
REG. NO. T20364

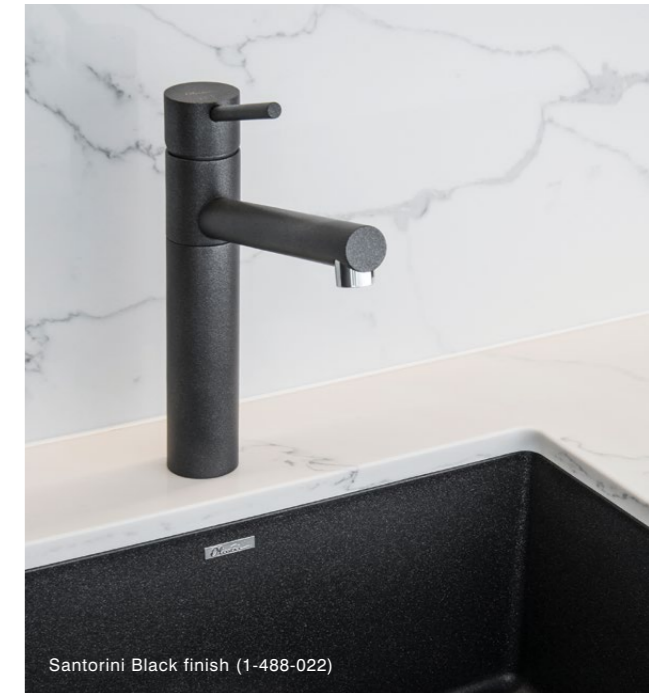

Santorini Black finish (1-488-022)

MITO RANGE

FEATURES

Italian made

Mito taps are made in Italy to ensure premium quality and reliability.

Functionality

The pull out style offers added functionality.

Filtered water

Pair this tap with an Oliveri Inline Water Filter for pure filtered water in your own home.

Warranty

15 years



Pull out mixer

Maximum pressure / 600kpa

1-488-019 | MT0079C
WELS 4 Star / 6.5L per minute
REG. NO. T20414

Pull out mixer

Maximum pressure / 600kpa

1-488-018 | MT0079B
WELS 4 Star / 6.5L per minute
REG. NO. T20413



Chrome finish (1-488-019)



Featured products:
Santorini 1&3/4 bowl (1-487-615)
and Vilo pull out mixer (1-488-010)

OLIVERI

Vilo taps are made in Italy to ensure premium quality and reliability.

* Refer to www.oliveri.com.au/service-and-warranty-au for warranty details.

ESSENTE RANGE

FEATURES

Premium finish

All Essente taps are constructed from premium stainless steel.

Variety

A variety of styles to suit your kitchen design.

Functionality

Pull out styles available for added functionality.

Filtered water

Pair these taps with an Oliveri Inline Water Filter for pure filtered water in your own home.

Warranty

10 years

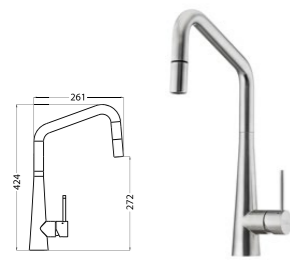

Square goose neck pull out mixer
Maximum pressure / 500kpa

1-488-030 | SS2575
WELS 4 Star / 7.5L per minute
REG. NO. T29756

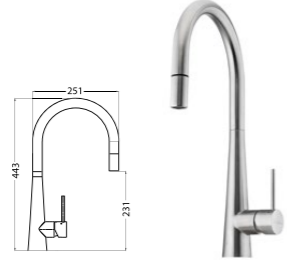

Goose neck pull out mixer
Maximum pressure / 500kpa

1-488-027 | SS2525
WELS 4 Star / 7.5L per minute
REG. NO. T29868

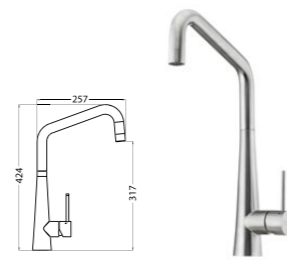

Square goose neck mixer
Maximum pressure / 500kpa

1-488-029 | SS2570
WELS 4 Star / 7.5L per minute
REG. NO. T29753

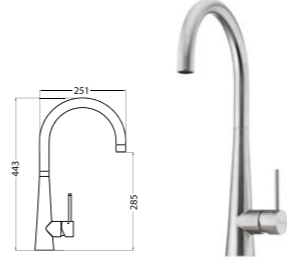

Goose neck mixer
Maximum pressure / 500kpa

1-488-026 | SS2520
WELS 4 Star / 7.5L per minute
REG. NO. T29752

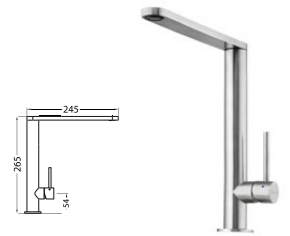

Right angle mixer
Maximum pressure / 500kpa

1-488-028 | SS2540
WELS 4 Star / 7.5L per minute
REG. NO. T29757

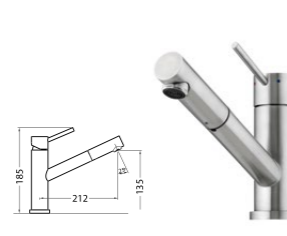

Swivel pull out mixer
Maximum pressure / 500kpa

1-488-025 | SS2515
WELS 4 Star / 7.5L per minute
REG. NO. T29754

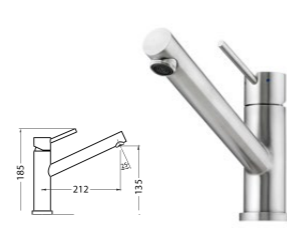

Swivel mixer
Maximum pressure / 500kpa

1-488-024 | SS2510
WELS 4 Star / 7.5L per minute
REG. NO. T29755

- C CHROME
- B BRUSHED
- S STAINLESS STEEL
- MB MATTE BLACK
- SB SANTORINI BLACK
- SW SANTORINI WHITE

ESSENTIALS RANGE

FEATURES

Affordable luxury

Chrome finish taps in a variety of styles to compliment your kitchen design.

Filtered water

Pair these taps with an Oliveri Inline Water Filter for pure filtered water in your own home.

Functionality

Pull out styles available for added functionality.

Warranty

10 years

ALSO AVAILABLE

CHECK OUT OUR RANGE OF GERMAN MADE HANSGROHE TAPS.

German made Hansgrohe taps add style and simplicity to every setting. Oliveri offers an exclusive range of premium Hansgrohe taps.

For further information visit

lincolnsentry.com.au/oliveri



Goose neck pull out mixer
Maximum pressure / 500kpa

1-488-041 | ES520-P
WELS 4 Star / 7.5L per minute
REG. NO. T29271



Goose neck mixer
Maximum pressure / 500kpa

1-488-040 | ES520
WELS 4 Star / 7.5L per minute
REG. NO. T29265

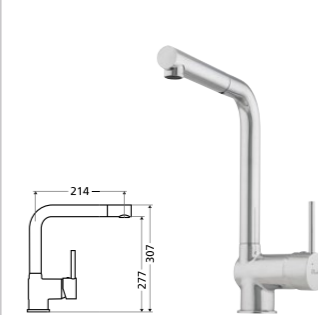

Pull out right angle mixer
Maximum pressure / 500kpa

1-488-043 | ES570-P
WELS 4 Star / 7.5L per minute
REG. NO. T29269



Right angle mixer
Maximum pressure / 500kpa

1-488-042 | ES570
WELS 4 Star / 7.5L per minute
REG. NO. T29268



Pull out swivel mixer
Maximum pressure / 500kpa

1-488-047 | ES590-P
WELS 4 Star / 7.5L per minute
REG. NO. T29394

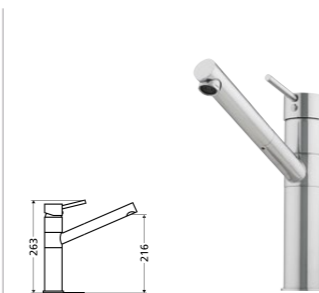

Swivel mixer
Maximum pressure / 500kpa

1-488-046 | ES590
WELS 4 Star / 7.5L per minute
REG. NO. T29270

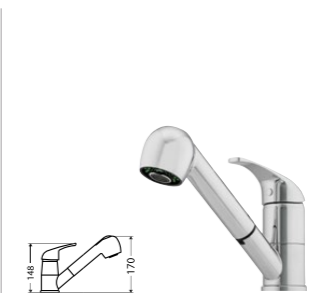

Pull out spray mix
Maximum pressure / 500kpa

1-488-045 | ES580-P
WELS 4 Star / 7.5L per minute
REG. NO. T29266



Single lever mixer
Maximum pressure / 500kpa

1-488-044 | ES580
WELS 4 Star / 7.5L per minute
REG. NO. T29333



Featured products:
Essente square goose neck pull out mixer (1-488-030)

Choosing a laundry sink



The sink

In addition to our purpose-built laundry tubs, many of our kitchen sinks are perfectly suited for use in your laundry. A deep bowl kitchen sink, for example, provides ample space for soaking clothes and filling buckets.

Colour

Our sinks are available in a range of hues, such as our copper Spectra or black Santorini designs. Plus there's an option to integrate a contemporary palette with the choice of black or white Vilo mixer taps.

Overflow and bypass plumbing

Avoid accidental overfilling by choosing a sink with an inbuilt overflow option. Our laundry range also offers bypass plumbing that diverts washing machine grey water to drainage below the waste outlet.

Bench depth

While 600mm is the standard depth of a kitchen bench we recommend that laundry benches are a minimum of 650mm deep. As well as providing the option to install a large laundry tub, having this extra depth will also help you accommodate any hoses that are tucked behind your washing machine.

Cabinet width

It's important that you consider the width of your cabinets as laundry sinks can be larger than kitchen

sinks. The Oliveri T170 laundry tub, for instance, requires a minimum cabinet width of 700mm.

Pull-out spray mixer taps

Mixer taps with a pull-out spray provide you with extra reach and added flexibility. They are especially useful for cleaning the sink, rinsing clothes and filling bulky items like mop buckets.

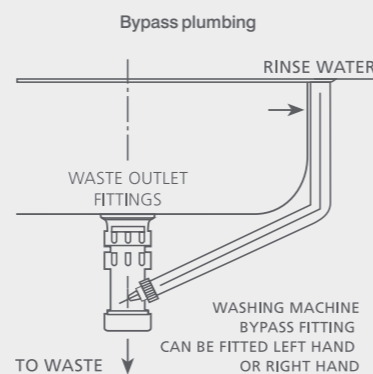

TI45
1-487-145
TI45S
1-487-145BP
TI45S/OF
1-487-180



T170
1-487-183
T170S
1-487-147



DU490
1-487-484



Featured products:
45L laundry tub and Essentials
goose neck pull out mixer
(1-488-041)

Look for a single deep bowl for soaking clothes or filling buckets. If space is limited, go for a standard single bowl kitchen sink.



Make easy work of household laundry with a range of accessories designed for your convenience.

HOT TIP

Maximise your space and make organising laundry easier by adding a hanging rail or a laundry valet to hang clothes.

DESIGN TIP

LAUNDRY ACCESSORIES

Use space more efficiently with accessories such as pull out ironing boards, laundry hampers, vacuum cleaner storage systems and wall-mounted iron holders.

For further information visit

lincolnsentry.com.au/laundry

A RANGE OF SINKS TO SUIT ANY BUDGET

Fit within your space and your budget with our range of laundry sinks offered in multiple sizes, designs and materials. From standard stainless steel through to stunning new granite and quartz resin bowls with glass covers.

STANDARD

PREMIUM



TI45
1-487-145

Standard laundry tub
Made in Australia. Available with a rinse bypass and overflow



EE50U
1-487-214

Endeavour single bowl
Made in Australia



SN1050U
1-487-950

Sonetto single bowl
Hand made with tight radius corners



ST-BL1551
1-487-620

Santorini single bowl
Granite sink

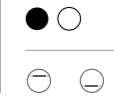

SB50CU
1-487-648

Spectra single bowl
Coloured stainless steel. Available in stainless steel, gun metal and copper



Inspired design and functionality that's assured to last a lifetime

OLIVERI SINK LIFETIME WARRANTY

All Oliveri sinks are accompanied by a Lifetime Manufacturer's Warranty that complies with the Competition and Consumer Act (2010) in Australia. You are entitled to a replacement or refund for a major failure and for compensation for any other reasonably foreseeable loss or damage. You are also entitled to have the goods repaired or replaced if the goods fail to be of acceptable quality and the issue does not amount to a major failure.

For warranty details refer to

oliveri.com.au/service-and-warranty-au



LINCOLN
SENTRY

Oliveri



Ph: 1300 551 919 / Fax: 1300 739 656

www.lincolnsentry.com.au

Get social

